

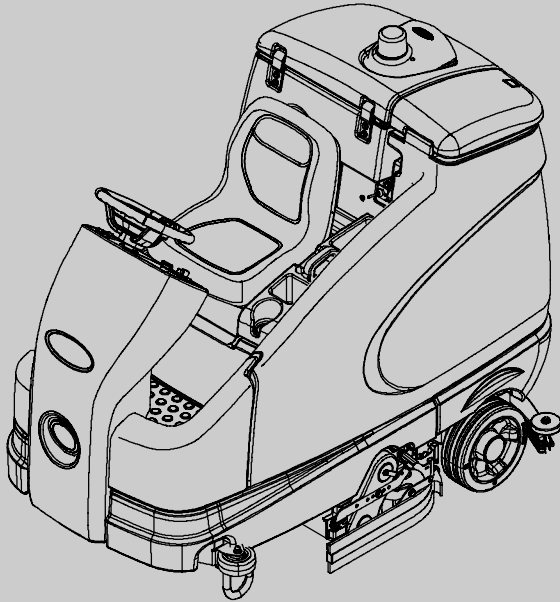

T16

(Battery)

Rider Scrubber
English **EN**
Operator Manual



www.tennantco.com

9008308
Rev. 00 (3-2011)





This manual is furnished with each new model. It provides necessary operation and maintenance instructions.

Read this manual completely and understand the machine before operating or servicing it.

This machine will provide excellent service. However, the best results will be obtained at minimum costs if:



- The machine is operated with reasonable care.
- The machine is maintained regularly - per the machine maintenance instructions provided.
- The machine is maintained with manufacturer supplied or equivalent parts.

	PROTECT THE ENVIRONMENT Please dispose of packaging materials, old machine components such as batteries, hazardous fluids including antifreeze and oil, in an environmentally safe way according to local waste disposal regulations.
	Always remember to recycle.

MACHINE DATA	
Please fill out at time of installation for future reference.	
Model No. -	_____
Serial No. -	_____
Machine Options -	_____
Sales Rep. -	_____
Sales Rep. phone no. -	_____
Customer Number -	_____
Installation Date -	_____

Tennant N.V.
Industrielaan 6 5405 AB
P.O. Box 6 5400 AA Uden-The Netherlands
europe@tennantco.com
www.tennantco.com

Specifications and parts are subject to change without notice.
Original Instructions, copyright © 2011 TENNANT Company, Printed in U.S.A.

 TENNANT N.V. Industrielaan 6 5405 AB P.O. Box 6 5400 AA Uden - The Netherlands Uden, 21-05-2010 	DECLARATION OF CONFORMITY FOR MACHINERY (according to Annex II A of the Machinery Directive) Herewith declares, on our own responsibility, that the machinery T16 - is in conformity with the provisions of the Machinery Directive (2006/42/EC), as amended and with national implementing legislation - is in conformity with the provisions of the Electro Magnetic Compatibility Directive 2004/108/EC and that - the following harmonized standards or parts of these standards have been applied: EN ISO 14121-1, EN 1037, EN 60335-1, EN 60204-1, EN ISO 13849-1, EN ISO 13849-2, EN 60529, EN ISO 4413, EN 349, EN 55012, EN 61000-6-2, EN ISO 11201, EN ISO 4871, EN ISO 3744*, EN ISO 13059*, EN ISO 3450, EN 60335-2-72. - the following national standards or parts of these standards have been used:
--	---

CONTENTS

	Page		Page
Safety Precautions	2	Maintenance	38
Operation	4	Maintenance Chart	38
Machine Components	4	Batteries	40
Controls And Instruments	5	Charging The Batteries	
Touch Panel	6	(Off-Board Charger)	41
Symbol Definitions	7	Circuit Breakers	42
Operation Of Controls	8	Scrub Brushes	43
Battery Discharge Indicator	8	Disk Brushes And Pads	43
Hour Meter	8	Replacing Disk Brushes Or	
Recovery Tank Indicator	8	Pad Drivers	43
Solution Tank Indicator	8	Replacing Disk Scrub Pads	44
Power Kill Switch	9	Cylindrical Brushes	45
Operating / Hazard Light Switch (Option)	9	Replacing Cylindrical Scrub Brushes	45
Seat Support Arm	9	Side Brush (Option)	46
Operator Seat	10	Replacing The Side Brush	46
Deluxe Suspension Seat (Option)	10	Pre-Sweep Brushes (Option)	47
Seat Belts	10	Replacing The Pre-Sweep Disk	
Contrast Control Button	11	Brushes (Option)	47
Configuration Mode Button	11	Replacing The Pre-Sweep Cylindrical	
Propel Pedal	11	Brush (Option)	48
Brake Pedal	11	FaST System	49
Directional Switch	11	Replacing The FaST-PAK Carton	49
Vacuum Fan / Squeegee Button	12	Cleaning The FaST Supply Hose	
Solution On / Off Buttons	12	Connector	49
How The Machine Works	13	Squeegee Blades	50
While Operating The Machine	13	Replacing (Or Rotating) The Rear	
Pre-operation Checklist	14	Squeegee Blades	50
Starting The Machine	15	Leveling The Rear Squeegee	53
Filling The Solution Tank	15	Adjusting The Rear Squeegee Blade	
Foam Scrubbing (FaST Mode) / ec-H2O		Deflection	54
Scrubbing (ec-H2O Mode)	15	Replacing Or Rotating The Side	
Conventional Scrubbing Mode	16	Squeegee Blades	55
ES (Extended Scrub) Mode	17	Replacing Or Rotating The Side Brush	
Setting Scrub Modes	18	Squeegee Blades (Option)	56
Setting Brush Pressure	18	Pushing, Towing, And Transporting	
Setting Solution Flow	18	The Machine	58
Conventional Solution Flow	18	Pushing Or Towing The Machine	58
ES (Extended Scrub) Solution Flow	18	Transporting The Machine	58
Scrubbing	19	Machine Jacking	59
Double Scrubbing	20	Storage Information	59
Water Pickup Mode (No Scrubbing)	21	Priming The ec-H2O System	60
Stop Scrubbing	21	Specifications	61
Draining And Cleaning The		General Machine Dimensions/Capacities ..	61
Recovery Tank	22	General Machine Performance	61
Draining And Cleaning The Solution Tank		Machine Dimensions	62
(ES Machines Only)	24		
Stop The Machine	25		
Fault Indicator(s)	26		
Warning Codes	27		
Options	28		
Side Brush (Option)	28		
Pre-Sweep Assembly (Option)	28		
Empty The Pre-Sweep Debris			
Hopper	29		
Vacuum Wand (Option)	30		
Rollout Battery (Option)	32		
Rear Squeegee Guard (Option)	33		
Spray Nozzle (Option)	34		
Machine Troubleshooting	36		

SAFETY PRECAUTIONS

The following precautions are used throughout this manual as indicated in their description:

 **WARNING:** To warn of hazards or unsafe practices that could result in severe personal injury or death.

 **CAUTION:** To warn of unsafe practices that could result in minor or moderate personal injury.

FOR SAFETY: To identify actions that must be followed for safe operation of equipment.

This machine is designed solely for scrubbing dirt and dust in a well lit indoor environment. Tennant does not recommend using this machine in any other environment.

The following information signals potentially dangerous conditions to the operator or equipment. Read this manual carefully. Know when these conditions can exist. Locate all safety devices on the machine. Then, take necessary steps to train machine operators. Report machine damage or faulty operation immediately. Do not use the machine if it is not in proper operating condition.

 **WARNING:** Batteries emit hydrogen gas. Explosion or fire can result. Keep sparks and open flame away. Keep covers open when charging.

 **WARNING:** Flammable materials can cause an explosion or fire. Do not use flammable materials in tank(s).

 **WARNING:** Flammable materials or reactive metals can cause an explosion or fire. Do not pick up.

FOR SAFETY:

1. Do not operate machine:
 - Unless trained and authorized.
 - Unless operation manual is read and understood.
 - With brake disabled.
 - If it is not in proper operating condition.
 - In flammable or explosive areas.
 - In areas with possible falling objects unless equipped with overhead guard.

2. Before starting machine:
 - Make sure all safety devices are in place and operate properly.
 - Check brakes and steering for proper operation.
 - Adjust seat and fasten seat belt (if so equipped).
3. When using machine:
 - Do not pick up burning or smoking debris, such as cigarettes, matches or hot ashes
 - Go slowly on inclines and slippery surfaces.
 - Use care when backing machine.
 - Do not carry passengers on machine.
 - Follow mixing and handling instructions on chemical containers.
 - Report machine damage or faulty operation immediately.
4. Before leaving or servicing machine:
 - Stop on level surface.
 - Turn off machine and remove key.
5. When servicing machine:
 - Avoid moving parts. Do not wear loose clothing or jewelry when working on machine.
 - Block machine tires before jacking machine up.
 - Jack machine up at designated locations only. Block machine up with jack stands.
 - Use hoist or jack that will support the weight of the machine.
 - Wear eye and ear protection when using pressurized air or water.
 - Disconnect battery connections before working on machine.
 - Wear protective gloves and eye protection when handling vinegar.
 - Avoid contact with battery acid.
 - Use Tennant supplied or equivalent replacement parts.
6. When loading/unloading machine onto/off truck or trailer.
 - Turn off machine.
 - Use truck or trailer that will support the weight of the machine.
 - Block machine tires.
 - Tie machine down to truck or trailer.

The safety labels appear on the machine in the locations indicated. Replace damaged labels.

BATTERY CHARGING LABEL - LOCATED ON SEAT PANEL.



FLAMMABLE MATERIALS LABEL - LOCATED ON UNDERSIDE OF RECOVERY TANK COVER AND ON CIRCUIT BREAKER PANEL.



FLAMMABLE SPILLS LABEL - LOCATED ON UNDERSIDE OF SOLUTION TANK COVER.

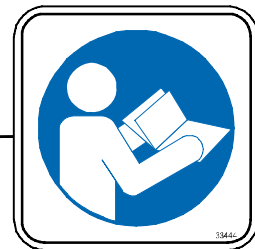
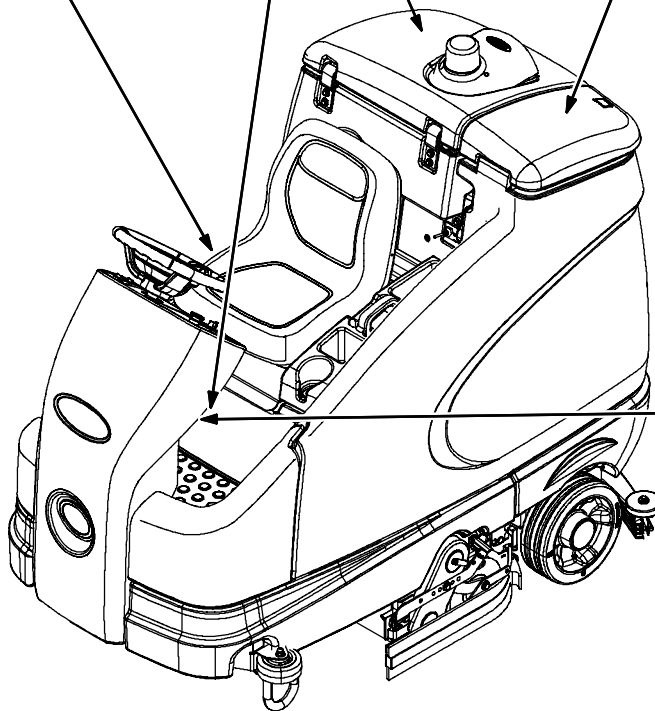
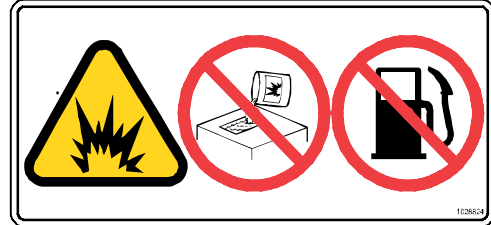

FOR SAFETY LABEL - LOCATED ON CIRCUIT BREAKER PANEL.

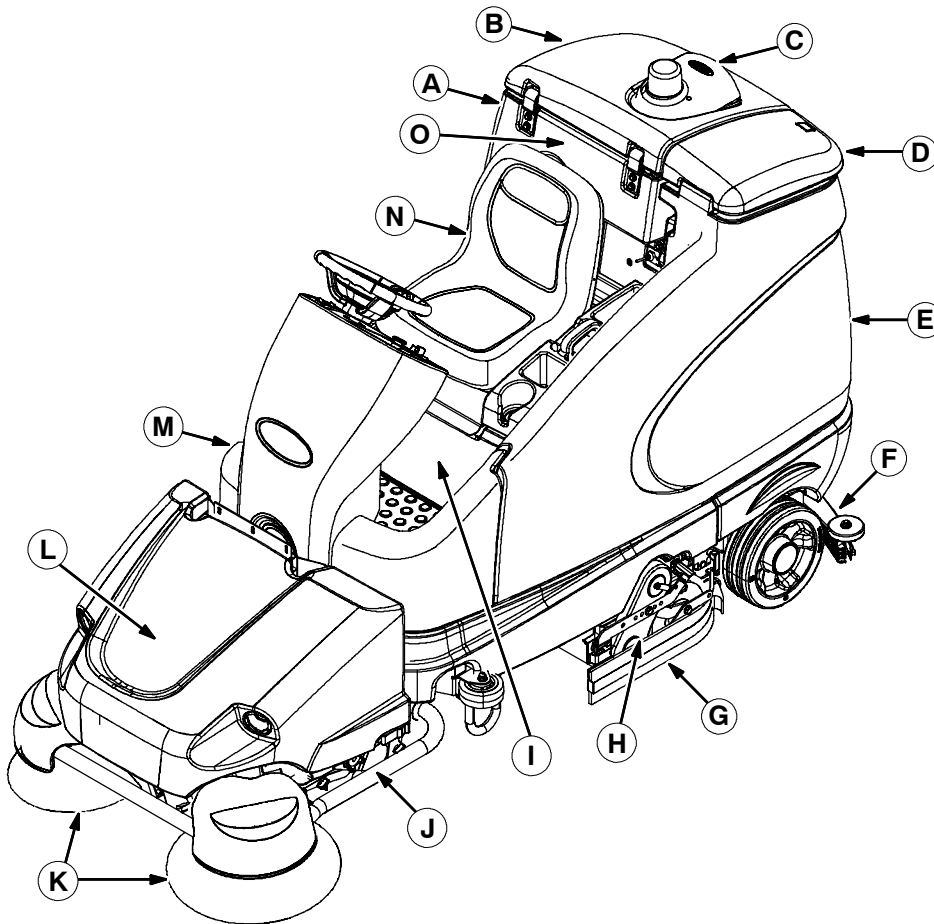
MACHINE COMPONENTS

356071

- A. Recovery tank
- B. Recovery tank cover
- C. Backup alarm / flashing light (option)
- D. Solution tank cover
- E. Solution tank
- F. Rear squeegee
- G. Side squeegee
- H. Scrub head
- I. Battery compartment
- J. Pre-Sweep assembly (option)
- K. Pre-Sweep side brush(es) (option)
- L. Pre-Sweep debris hopper (option)
- M. Side brush (option)
- N. Operator seat
- O. FaST PAK (option)
ec-H20 System Module (option)
FaST solution system (option)

CONTROLS AND INSTRUMENTS



- A. Steering wheel
- B. Touch panel
- C. Side brush switch (option)
- D. Spray nozzle switch (option)
- E. Brake pedal
- F. Propel pedal
- G. Directional switch
- H. Operating lights / hazard lights switch (option)
- I. Key switch
- J. Pre-Sweep switch (option)
- K. Power kill switch



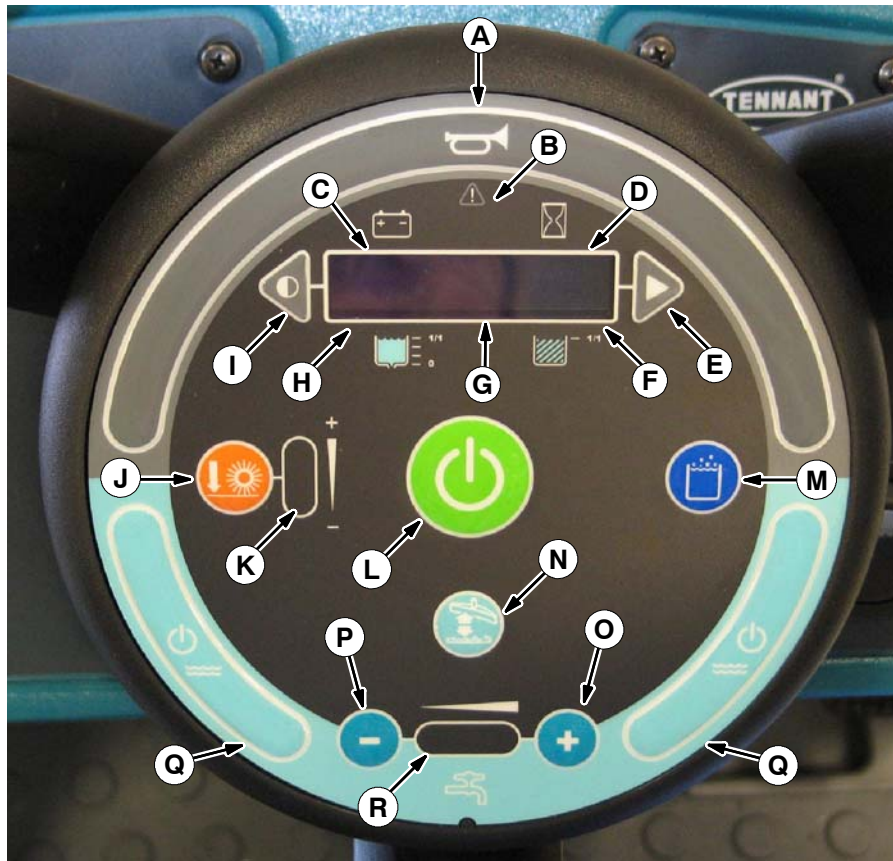







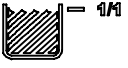







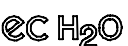











TOUCH PANEL

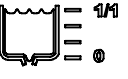

- A. Horn
- B. Warning / fault indicator light
- C. Battery discharge indicator
- D. Hour meter
- E. Configuration mode button
- F. Recovery tank indicator
- G. LCD display
- H. Solution tank indicator
- I. Contrast control button
- J. Brush pressure button
- K. Brush pressure indicator lights
- L. 1-Step button
- M. Scrub mode (ec-H₂O / FaST / ES / conventional) button
- N. Vacuum fan / squeegee button
- O. Solution increase button (+)
- P. Solution decrease button (-)
- Q. Solution on / off buttons
- R. Solution flow indicator lights

SYMBOL DEFINITIONS

These symbols are used on the machine to identify controls, displays, and features.

	Fault indicator		Recovery tank
	Vacuum fan / squeegee		Operating lights
	1-STEP		Hazard light
	ES (extended scrub)		Scrub mode
	FaST (foam scrubbing)		Circuit breaker
	ec-H2O (option)		Spray nozzle
	Solution flow		Pre-Sweep
	Increase		Pre-sweep / Vacuum fan
	Decrease		On
	Main brush pressure		Off
	Side brush		Solution On / Off
	Battery charge		Emergency shutoff
	Horn		Contrast control
	Hour meter		Jack point
	Solution tank		Solution flow (maximum / minimum)
	Forward / Reverse		Brush pressure (maximum / minimum)

OPERATION

OPERATION OF CONTROLS

BATTERY DISCHARGE INDICATOR

The *battery discharge indicator* displays the charge level of the batteries while the machine is operating.



When the batteries are fully charged, all five bars are lit. Recharge the batteries when there are no longer any bars shown in the display.

NOTE: The reading on the battery discharge indicator is not accurate when the machine is first powered on. Operate the machine a few minutes before reading the charge level of the batteries.

NOTE: The battery discharge indicator will not reset from the flashing indicator (lowest bar on the indicator) unless the batteries have been fully charged.

HOUR METER

The *Hour meter* records the hours the machine was operated. Use this information to determine machine service intervals.



RECOVERY TANK INDICATOR

The *recovery tank indicator* displays the amount of liquid in the recovery tank. All scrubbing functions will stop when the recovery tank is full. Empty the recovery tank when the indicator reaches 100%.



SOLUTION TANK INDICATOR

The *solution tank indicator* displays the amount of liquid in the solution tank. Refill the solution tank when there are no longer any bars shown in the display. The machine will stop scrubbing when the solution tank is empty.



POWER KILL SWITCH

The *power kill switch* immediately stops all power to the machine.

Stop machine power: Press the power kill switch.

Restart machine power: Turn the power kill switch to the right to release the switch. Turn the key switch off, then turn the key fully clockwise and release it to the On position.



OPERATING / HAZARD LIGHT SWITCH (OPTION)

Operating and Hazard Lights On: Press the top of the *Operating / hazard light switch*.

Operating Lights On: Press the *Operating / hazard light switch* to the middle position.

All Lights Off: Press the bottom of the *Operating / hazard light switch*.



SEAT SUPPORT ARM

The *seat support arm* holds the seat up to allow access to the batteries and circuit breakers.

To engage the seat support arm, lift the seat completely open and insert the seat support arm into the hole in the operator seat plate.

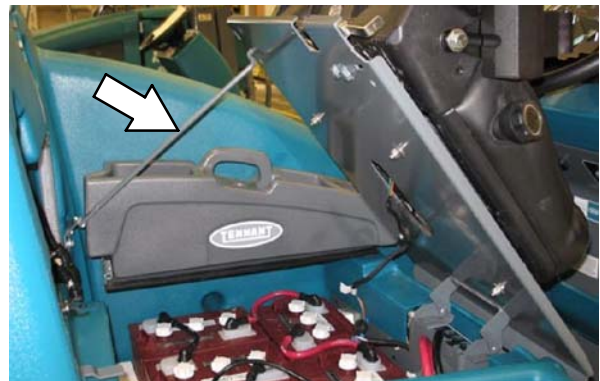
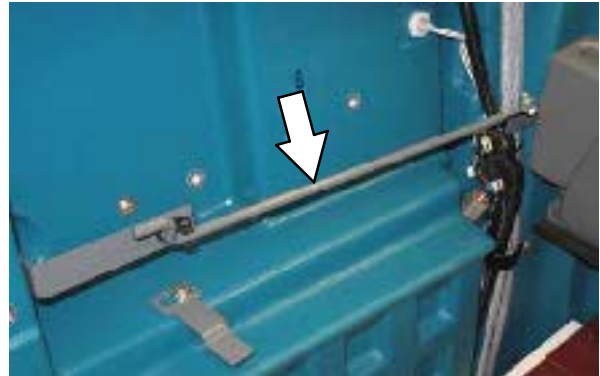

OPERATION

OPERATOR SEAT

The front-to-back adjustment lever adjusts the seat position.



The lumbar knob adjusts the lower backrest portion of the seat.



DELUXE SUSPENSION SEAT (OPTION)

The operator seat has four adjustments: backrest angle, operator weight, lumbar, and front to back.

Use caution when tilting the deluxe seat. The deluxe seat is heavier than the standard seat.

The backrest adjustment knob adjusts the angle of the backrest.



The front-to-back adjustment lever adjusts the seat position.



SEAT BELTS

FOR SAFETY: Before starting machine, adjust seat and fasten seat belt.



The weight adjustment knob controls the firmness of the operator seat. Use the gauge next to the weight adjustment knob to help determine seat firmness.

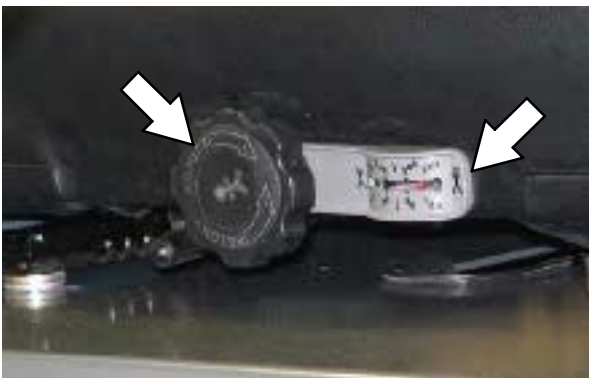

CONTRAST CONTROL BUTTON

Use the *Contrast control button* to darken / lighten the LCD display.



CONFIGURATION MODE BUTTON

The *Configuration mode button* is for accessing the configuration and diagnostic modes. Only properly trained service personnel and TENNANT representatives should access these modes.



PROPEL PEDAL

Press the *Propel pedal* to move the machine.



BRAKE PEDAL

Press the *Brake pedal* to stop the machine.



DIRECTIONAL SWITCH

Use the *Directional switch* to select either the forward or reverse direction. Press the propel pedal to move the machine.



NOTE: An audible alarm will sound when the Directional switch is placed into reverse.

NOTE: Machines equipped with the optional flashing light / backup alarm only: The optional backup light and alarm will function only when the machine is moving in reverse.

OPERATION

VACUUM FAN / SQUEEGEE BUTTON

Lower squeegee and turn vacuum fan on: Press the *Vacuum fan / squeegee button*. The indicator light will illuminate when the squeegee is lowered.

Raise squeegee and turn vacuum fan off: Press the *Vacuum fan / squeegee button*. The indicator light will go out when the squeegee is raised.

NOTE: The 1-STEP button does not need to be activated to operate the vacuum fan / squeegee system. The vacuum fan / squeegee button can be turned on or turned off with the 1-STEP button either on or off.



SOLUTION ON / OFF BUTTONS

Shut off the solution flow: Press the *Solution on / off button* to shut off the solution flow. All the solution flow indicator lights will turn off.

Turn on the solution flow: Press the *Solution on / off button* to turn on the solution flow. The solution indicator lights will turn back on and the solution flow will default to the last setting used.



HOW THE MACHINE WORKS

The *1-STEP button* makes it possible to immediately begin scrubbing by operating all the scrubbing functions.

When in the conventional Scrub mode, a water and detergent mixture is used to scrub the floor.

When in the optional ES (Extended Scrub) mode, the dirty solution in the recovery tank is filtered through the ES system and returned to the solution tank for reuse. Detergent is then injected into the returned solution to revitalize the cleaning capability of the solution.

When in the optional FaST (Foam scrubbing) mode, the FaST scrubbing system mixes the FaST-PAK concentrate with a small amount of water, creating a large volume of expanded wet foam. The FaST system can be used with all scrubbing applications.

When in the optional *ec-H₂O* (electrically converted water) mode, normal water passes through a module where it is oxygenated and charged with an electric current. The electrically converted water changes into a blended acidic and alkaline solution forming a neutral pH cleaner. The converted water attacks the dirt, breaks it into smaller particles, and pulls it off the floor surface allowing the machine to easily scrub away the suspended soil. The converted water then returns to normal water in the recovery tank. The *ec-H₂O* system can be used with all double scrubbing and heavy duty scrubbing applications.

WHILE OPERATING THE MACHINE

Pick up oversized debris before scrubbing. Pick up wire, string, twine, large pieces of wood, or any other debris that could become wrapped around or tangled in the brushes.

Drive in a straight a path as possible. Avoid bumping into posts or scraping the sides of the machine. Overlap the scrub paths by several centimeters (a few inches).

Avoid turning the steering wheel too sharply when the machine is in motion. The machine is very responsive to the movement of the steering wheel. Avoid sudden turns, except in emergencies.

Adjust the machine speed, brush pressure, and solution flow as required when scrubbing. Use the lowest brush pressure and solution flow settings for best performance.

If poor cleaning performance is observed, stop cleaning and refer to *MACHINE TROUBLESHOOTING* in this manual.

Perform the Daily Maintenance Procedures after each use (see *MACHINE MAINTENANCE* in this manual).

Drive the machine slowly on inclines. Use the brake pedal to control machine speed on descending inclines. Scrub with the machine up inclines rather than down inclines.

FOR SAFETY: When using machine, go slowly on inclines and slippery surfaces.

The maximum rated incline for scrubbing with the machine is 4° or 7%. The maximum rated incline during transport of the machine is 8° or 14%.

PRE-OPERATION CHECKLIST

Perform the following steps before operating the machine:

- Check the operating lights.
- Check left side squeegee for wear and damage.
- Check main brushes for wear and damage. Remove wire, string, or twine wrapped around the main scrub brushes.
- Machines equipped with cylindrical brushes: Confirm the debris tray is empty and clean.
- Machines equipped with side brush option: Check for wire, string, or twine wrapped around the scrub brush.
- Machines equipped with side brush option: Check squeegee for wear and damage.
- Machines equipped with Pre-Sweep option: Check for wire, string, or twine wrapped around the scrub brush.
- Machines equipped with Pre-Sweep option: Check dust control filter bag.
- Machines equipped with Pre-Sweep option: Confirm debris trough is empty.
- Check the rear squeegees for wear and damage.
- Check the recovery and solution tank cover seals for wear or damage.
- Confirm the vacuum fan inlet filter is clean.
- Check the right side squeegee for wear and damage.
- Machines equipped with ES option: Ensure ES filter at bottom of recovery tank is clean.
- FaST Scrubbing: Check the FaST PAK concentrate agent level, replace carton as needed. See the INSTALLING THE FaST PAK AGENT section of the manual.
- For FaST or *ec-H2O* Scrubbing: Confirm all conventional cleaning agents/restorers are drained and rinsed from the solution tank.
- For FaST or *ec-H2O* Scrubbing: Confirm the solution tank is filled with **clear cool water only**.
- Check the brakes and steering for proper operation.
- Check the tires for damage.
- Check maintenance records to determine maintenance requirements.

STARTING THE MACHINE

FOR SAFETY: Before starting machine, adjust seat and fasten seat belt.

1. Sit in the operators seat.
2. Turn the *key switch* completely past the on position and release the key switch. The key switch will automatically return to the on position.



3. Place the *directional switch* into the direction needed to travel.
4. Press the *propel pedal* to move the machine.

NOTE: The machine will not travel unless the operator is sitting in the operator seat.

FILLING THE SOLUTION TANK

FOAM SCRUBBING (FaST MODE) / ec-H2O SCRUBBING (ec-H2O MODE)

FOR SAFETY: Before leaving or servicing machine, stop on level surface and turn off machine.

1. Open the solution tank cover.



2. Fill the solution tank with only clean COOL WATER (less than 21°C / 70°F). DO NOT use hot water or add any conventional floor cleaning detergents or a FaST or ec-H2O system failure may result. Fill the solution tank with water until the level is approximately 50 mm (2 in) below the indicator tab.



⚠ WARNING: Flammable materials can cause an explosion or fire. Do not use flammable materials in tank(s).

NOTE: Do not use the FaST or ec-H2O system when there are conventional cleaning detergents in the solution tank. Drain, rinse, and refill the solution tank with clear cool water before operating the FaST or ec-H2O system. Conventional cleaning detergents may cause a FaST or ec-H2O system failure.

3. Close the solution tank cover.

OPERATION

CONVENTIONAL SCRUBBING MODE

FOR SAFETY: Before leaving or servicing machine, stop on level surface and turn off machine.

1. Open the solution tank cover.



2. Partially fill solution tank with water (not to exceed 60°C / 140°F). Pour the required amount of detergent into the solution tank. Continue filling the solution tank with water until the level is approximately 50 mm (2 in) below the indicator tab.

WARNING: Flammable materials can cause an explosion or fire. Do not use flammable materials in tank(s).



ATTENTION: For Conventional Scrubbing, only use recommended cleaning detergents. Machine damage due to improper detergent usage will void the manufacturer's warranty.

NOTE: Pour a recommended foam control solution into the recovery tank if excessive foam appears. For specific detergent recommendations, contact a Tennant representative.

3. Close the solution tank cover.

ES (EXTENDED SCRUB) MODE

FOR SAFETY: Before leaving or servicing machine, stop on level surface and turn off machine.

1. Open the solution tank cover.



2. Fill solution tank with water (not to exceed 60°C / 140°F). Fill the solution tank with water until the level is approximately 50 mm (2 in) below the indicator tab.



3. Fill the recovery tank with water (not to exceed 60°C / 140°F). Fill the recovery tank to just above the top of the ES filter.



4. Fill the ES detergent tank with detergent.



WARNING: Flammable materials can cause an explosion or fire. Do not use flammable materials in tank(s).



5. Close the solution tank cover.

OPERATION

SETTING SCRUB MODES

The *Scrub mode button* enables the scrubbing functions to come on when the *1-STEP button* is activated. The light and cleaning system logo next to the button will come on. The machine will default to the last setting used when it is powered on or off.



NOTE: When the ES system is turned on there is a slight delay before the ES pump begins operating.

SETTING BRUSH PRESSURE

Under normal cleaning conditions, the brush pressure should be set to the lowest setting (the bottom light). Under heavy grime conditions, the brush pressure can be set to a higher setting (the top two lights). Travel speed and floor conditions will affect cleaning performance.

With the *1-STEP button* activated, press the *Brush pressure button* to set the brush pressure. Use the *Brush pressure button* to both raise or lower the brush pressure settings. If brushes are worn, it may be necessary to increase the brush pressure. The machine will default to the last setting used when it is powered on or off.



SETTING SOLUTION FLOW

With the *1-STEP button* activated, press either *Solution increase button (+)* or *Solution decrease button (-)* to set the solution flow level. Travel speed and floor conditions will affect scrubbing performance. The machine will default to the last setting used when the machine is powered on or off. The solution flow indicator lights display the current solution flow setting.

NOTE: When using the FaST or ec-H2O system (option), the solution flow increase and solution flow decrease buttons are nonfunctional. The FaST and ec-H2O system flow rates are pre-set. All three solution flow indicator lights will be lit if the machine is in the ec-H2O or FaST mode.



CONVENTIONAL SOLUTION FLOW

Under normal soilage conditions the solution flow level should be set to the lowest setting (the left light). Under heavy grime conditions, the solution flow level should be set to the higher settings (middle or right lights).

ES (EXTENDED SCRUB) SOLUTION FLOW

For ES machines, the detergent flow is turned off when the solution flow is in the lowest setting (one light). The middle setting (two lights) and highest setting (three lights) allow solution AND detergent flow. The lowest setting (one light) allows solution flow WITHOUT adding detergent. Detergent does not have to be continuously added with the solution flow to attain effective scrubbing results. Under normal soilage conditions, the solution flow level should be alternated between the middle and lowest setting.

SCRUBBING

FOR SAFETY: Do not operate machine, unless operator manual is read and understood.

1. Start the machine.
2. Press the *1-STEP button*. The light near the button will come on. All the preset scrubbing functions will turn on.



3. Press the *scrub mode button* to select the scrub mode (ec-H2O, FaST, or ES). The indicator light and mode logo will illuminate.



4. If necessary, adjust the brush pressure and solution flow.
5. Place the *directional switch* in the direction the machine is to be moved (forward or reverse).
6. Press the *propel pedal* to begin scrubbing.

NOTE: DO NOT turn on the FaST or ec-H2O system during conventional scrubbing. Conventional cleaning detergents could cause a FaST or ec-H2O system failure. Drain, rinse, and refill the solution tank with cool clean water before operating the FaST or ec-H2O system.

WARNING: Flammable materials or reactive metals can cause an explosion or fire. Do not pick up.

FOR SAFETY: When using machine, go slowly on inclines and slippery surfaces.

NOTE: The squeegee automatically rises when the machine is driven in reverse. This prevents damage to the squeegee.

ec-H2O Model: If an alarm sounds and the warning / fault indicator indicator light flashes the ec-H2O module must be flushed to resume ec-H2O operation (See ec-H2O MODULE FLUSH PROCEDURE).

NOTE: When the alarm sounds press the scrub mode button to shut off the ec-H2O system and continue scrubbing or flush the ec-H2O system.

ec-H2O SYSTEM INDICATOR LIGHT CODE	CONDITION
Solid blue indicator light	Normal operation
Flashing red warning / fault indicator light	Flush ec-H2O module
Solid red warning / fault indicator light	Contact Service Center

7. Release the *directional pedal* and press the *brake pedal* to stop the machine.
8. Press the *1-STEP button* to stop scrubbing. The light near the button will go off and scrubbing functions will stop after a short delay.

OPERATION

DOUBLE SCRUBBING

Use the double scrubbing method to clean heavily soiled areas.

Double scrubbing can be performed using the FaST SCRUBBING SYSTEM (option), ec-H₂O SCRUBBING SYSTEM (option) or CONVENTIONAL SCRUBBING methods.

Pre-sweep and side brush (option) machines: Leave the Pre-sweep and side brush (options) in the raised position while double scrubbing.

To raise the side squeegees for double scrubbing, remove the clevis pins from the storage locations. Manually raise both side squeegee assemblies, then reinsert the pins into the holes in the side squeegee brackets.



Press the 1-STEP button and then the Vacuum fan/squeegee button. The light above the Scrub vacuum fan/squeegee button will turn off, the squeegee will rise, and the vacuum fan will stop operating. Scrub the heavily soiled area. Let the cleaning solution soak on the floor for 5-15 minutes.



FOR SAFETY: When using machine, go slowly on inclines and slippery surfaces.

Before scrubbing the floor a second time, lower the side squeegees and press the Vacuum fan/squeegee button to lower the rear squeegee and turn on the vacuum fan. The light above the button will come on. Scrub the floor a second time to pick up the cleaning solution.



WARNING: Flammable materials or reactive metals can cause an explosion or fire. Do not pick up.

NOTE: To turn off the solution flow when scrubbing the area a second time, press the Solution on / off button. Press the Solution on / off button again to restart the solution flow.



NOTE: Double scrubbing is not recommended in areas where the cleaning solution will run under racks or damage products.

WATER PICKUP MODE (NO SCRUBBING)

The machine can be used to pick up water or non-flammable liquid spills without scrubbing.

To pick up water or non-flammable liquid spills, make sure the *1-STEP button* is not activated. The light above the button must be off.



⚠ WARNING: Flammable materials or reactive metals can cause an explosion or fire. Do not pick up.

Press the *Vacuum fan/squeegee button*. The light above the button will come on, the squeegee will lower, and the vacuum fan will start operating. Pick up the water or non-flammable liquid spill.



STOP SCRUBBING

1. While the machine is still in motion, press the *1-Step button* to stop the scrubbing operations. The squeegee will briefly remain lowered to the floor to pick up the water in the scrub head.



2. Release the *propel pedal* and press the *brake pedal* to stop the machine.

OPERATION

DRAINING AND CLEANING THE RECOVERY TANK

Drain and clean the recovery tank daily or when the recovery tank full fault code appears on the LCD display.

Clean the outside of the tank with vinyl cleaner.

1. Drive the machine near a floor drain.

FOR SAFETY: Before leaving or servicing machine, stop on level surface and turn off machine.

2. Unhook the recovery tank drain hose from the recovery tank.

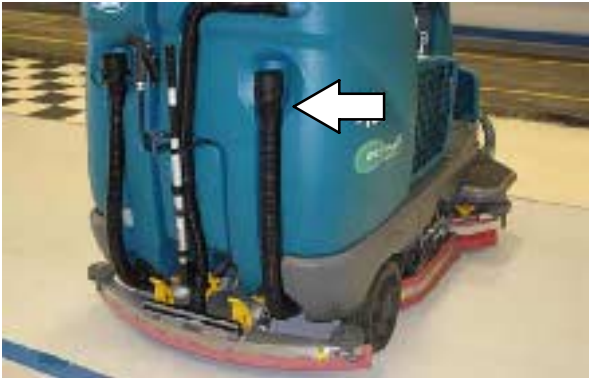

3. Hold the drain hose near a floor drain, twist the drain nozzle open, and place the hose near the floor drain.

NOTE: Be sure the drain hose nozzle is pointed in a safe direction before opening the nozzle.



4. If necessary, twist the drain nozzle to another position to adjust the flow rate.



5. Lift the recovery tank cover and flush out the recovery tank with clean water. Rinse the sensor near the top of the tank

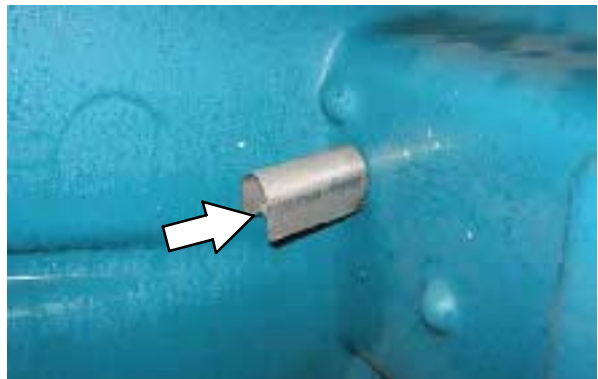

6. ES machines: Rinse the ES filter at the bottom of the tank and the sensor near the top of the tank.



NOTE: DO NOT use steam to clean the tanks. Excessive heat can damage the tanks and components.

7. To prevent leaks, clean the plug portion of the nozzle and the interior of the drain hose cuff.



8. Twist the drain cuff closed and hook the drain hose back onto the recovery tank.



9. Check the vacuum fan inlet filter daily. Clean inlet filter with a damp cloth or hose when dirty. Allow filter to completely dry before reinstalling it into the machine.



10. Close the recovery tank cover.

11. Cylindrical scrub head: Remove and clean the debris trough. Place the trough back in the scrub head when clean.



NOTE: The scrub head must be lowered approximately 25 mm (1 in) to remove debris trough.

NOTE: The debris trough can be removed from the right side of the machine only.

OPERATION

DRAINING AND CLEANING THE SOLUTION TANK (ES MACHINES ONLY)

ES machines: The solution tank should be drained and cleaned when the recovery tank is drained and cleaned.

Clean the outside of the tank with vinyl cleaner.

1. Drive the machine near a floor drain.

FOR SAFETY: Before leaving or servicing machine, stop on level surface and turn off machine.

2. Unhook the solution tank drain hose from the solution tank.



3. Hold the drain hose near a floor drain, twist the drain nozzle open, and place the hose near the floor drain.

NOTE: Be sure the drain hose nozzle is pointed in a safe direction before opening the nozzle.



4. If necessary, twist the drain nozzle to another position to adjust the flow rate.



5. Lift the solution tank cover and flush out the solution tank with clean water. Rinse the filter and sensor located inside the solution tank.

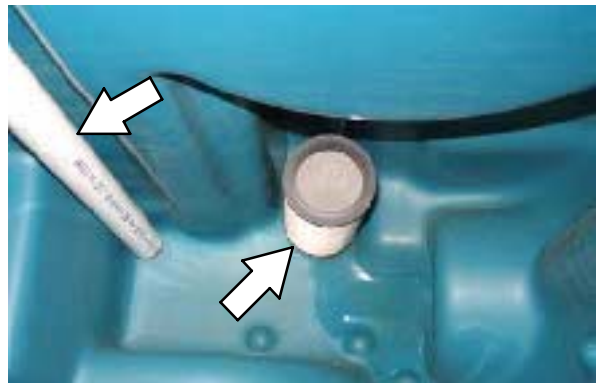

*NOTE: **DO NOT** use steam to clean the tanks. Excessive heat can damage the tanks and components.*

6. To prevent leaks, clean the plug portion of the nozzle and the interior of the drain hose cuff.



7. Twist the drain cuff closed and hook the drain hose back onto the solution tank.



STOP THE MACHINE

1. Remove foot from the *propel pedal*.
2. Press the *1-Step* button to stop scrubbing.
3. Press the *brake pedal* to stop the machine.
4. Turn the *key switch* to the off position.



OPERATION

FAULT INDICATOR(S)

This machine is equipped with two visual indicators, a red indicator light and an LCD (liquid crystal display).

The red indicator light will blink continuously indicating that a fault has occurred.



The LCD will display a fault code. If there is more than one fault, each fault code will alternately display.

All faults codes are also accompanied by an audible alarm to alert the operator a fault has occurred.

To reset the fault indicators, turn the machine off, then eliminate the cause of the fault. The fault indicator will reset when the machine is restarted.

Refer to the table below to determine the cause and remedy for the fault.

Fault Code (Displayed in LCD)	Cause(s)	Remedy
F1: Rec Tank Full	Recovery tank is full	Empty recovery tank
F2: Sol Tank Empty	Solution tank is empty	Fill solution tank.
F3: Vac # Flt #	vacuum fan motor(s) not operating	Shut off and restart machine. If fault code still appears, stop using machine and contact Tennant service representative.
F4: Batt Very Low	Low battery charge	Recharge battery
F5: Propel Error	Propel controller error	Turn off and restart machine.
F6: Left Br Flt #	Left brush not operating	If fault code still appears, stop using machine and contact Tennant service representative.
F6: Frnt Br Flt#	Front brush not operating	
F7: Rght Br Flt#	Right brush not operating	
F7: Rear Br Flt#	Rear brush not operating	
F8: Hi B3 Current	Side brush not operating	
F11: Act Timeout	Main head actuator time out fault	
F12: Check Brushes	Brushes not operating	
F13: Brsh Mtr Flt	Brush motor(s) not operating	

WARNING CODES

Warning codes are typically caused by the operator attempting to activate modes that are not available. The warning code will appear in the LCD.

Refer to the table below to determine the cause of the warning code.



Warning Code (Displayed in LCD)	Cause(s)	Remedy
W1: Batt. Low	Low battery charge	Charge batteries
W2: Sqge Stall	Squeegee not lowering	Check squeegee / squeegee actuator for obstructions or damage
W3: Side Stall	Side brush not lowering	Check side brush actuator for obstructions
W4: Unavailable	Optional solution not enabled	Solution mode not available
W5: No Side Brush	Side brush not enabled	Side brush not available
W6: Not Used	-	-
W7: Not Active	Button inactive	Button not active for use
W8: No Vac. Amps	Vacuum fan not operating	Check harness connection. Reconnect harness if it is unconnected. If warning code still appears, stop using machine and contact Tennant service representative.
W9: Open R/R Brush	Right / rear brush not operating	
W10: Open L/F Brush	Left / front brush not operating	
W11: Open SD Brush	Side brush not operating	Press Solution on / off button to start solution flow.
W12: Solution Off	No solution flow to scrub head	

OPTIONS

SIDE BRUSH (OPTION)

The side brush moves debris into the path of the main brushes.

WARNING: Flammable materials or reactive metals can cause an explosion or fire. Do not pick up.

1. Turn on the machine
2. Press the *1-Step* button.
3. Press the top of the *side brush switch* to lower and start the side brush.



4. Press the *propel pedal* to begin scrubbing.
5. Press the bottom of the *side brush switch* to stop and raise the side brush.

PRE-SWEEP ASSEMBLY (OPTION)

The Pre-Sweep assembly is mounted to the front of the machine and gives the machine the added ability to pick up debris. The assembly contains a main brush and two side brushes which sweep debris into a debris hopper. Periodically empty the debris hopper and vacuum debris bag.

The machine may be operated with or without the Pre-Sweep assembly. Refer to PRE-SWEEP in the MAINTENANCE section for maintenance.

WARNING: Flammable materials or reactive metals can cause an explosion or fire. Do not pick up.

1. Turn on the machine
2. Press the *1-Step* button.
3. Press the *Pre-Sweep switch* to the middle position to start the Pre-Sweep *without* dust control.

Press the *Pre-Sweep switch* to the top position to start the Pre-Sweep *with* dust control.

NOTE: The Pre-Sweep assembly will begin sweeping and the dust control system will start operating when the machine propels forward.



4. Press the bottom of *Pre-Sweep switch* to shut off the Pre-sweep system and dust control system.

EMPTY THE PRE-SWEEP DEBRIS HOPPER

FOR SAFETY: Before leaving or servicing machine, stop on level surface and turn off machine.

1. Lift the Pre-Sweep assembly cover and lock the cover open.



2. Remove the debris hopper from the Pre-Sweep assembly and empty the hopper.



3. Reinstall the debris hopper into the Pre-Sweep assembly.

4. Check the vacuum debris bag. Replace the vacuum debris bag if it is full or damaged.



5. Unlock and lower the Pre-Sweep cover.

OPERATION

VACUUM WAND (OPTION)

Use the vacuum wand to clean areas that are out of reach of the machine.

WARNING: Flammable materials or reactive metals can cause an explosion or fire. Do not pick up.

1. Unsnap the vacuum wand lanyard from the solution tank.



2. Remove the vacuum wand / squeegee vacuum hose from the rear squeegee.



3. Insert the vacuum wand cap into the vacuum port in the vacuum wand.



4. Twist the vacuum nozzle to the vacuum position and extend the handle to the desired length.



5. Press the *Vacuum fan/squeegee button* to turn on the vacuum fan. The squeegee will completely lower.



6. Vacuum the floor.



7. When finished vacuuming, press the *Vacuum fan/squeegee button* to turn off the vacuum fan. The squeegee will raise.

8. Turn off the machine.

9. Remove the vacuum wand cap from the vacuum port and return the vacuum nozzle to the storage position and the handle to the storage length.



10. Reinstall the vacuum wand / squeegee vacuum hose onto the rear squeegee.
11. Insert the vacuum hose into the vacuum hose recess in the recovery tank.



12. Snap the vacuum wand lanyard onto the solution tank to secure the vacuum wand / squeegee vacuum hose to the machine.

OPERATION

ROLLOUT BATTERY (OPTION)

The rollout battery allows the operator a quick and easy way to remove and replace the batteries from the machine.

FOR SAFETY: Before leaving or servicing machine, stop on level surface and turn off machine.

1. Lift the operator seat and engage the seat support arm.
2. Open the battery compartment door.



3. Disconnect the machine connector from the batteries.



4. Push the battery cart to the operator side of the machine and align the battery cart with the battery compartment.

5. Rotate the rollout battery retainer handle toward the front of the battery compartment, lower the rollout battery retainer plate, and insert the retainer plate catch into the slot in the battery cart.

NOTE: The retainer plate catch must be completely inserted into the slot in the battery cart to hold the battery retainer handle up and allow the batteries to be safely pulled from the battery compartment.



6. Step on the left side of floor lock to set the battery cart floor lock.



7. If necessary, adjust the height of the battery cart rollers. The battery cart rollers must be level with the machine battery rollers. Adjust the height on both sides of the battery cart.

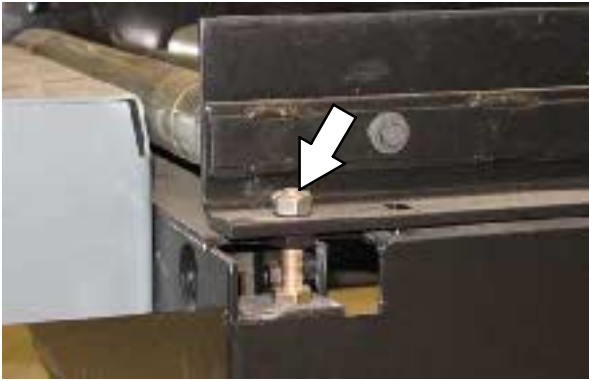

Raise battery cart rollers: Use a wrench to loosen the jam nut and turn the bolt clockwise. Retighten the jam nut.

Lower battery cart rollers: Use a wrench to loosen the jam nut and turn the bolt counter-clockwise. Retighten the jam nut.

8. Pull the battery case onto the battery cart.



9. Pull up on the handle to lower the cart battery stop bar. This will keep the batteries from rolling off the cart.

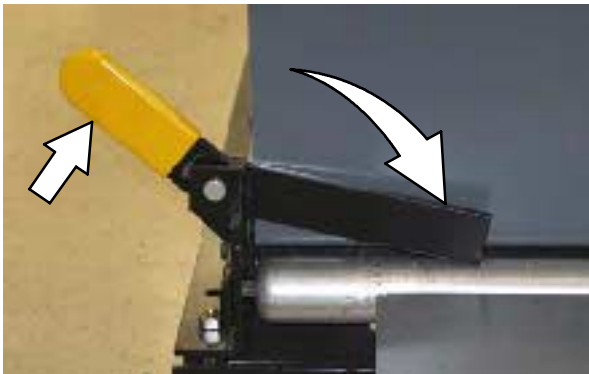

10. Raise the rollout battery retainer plate to release the battery cart from the machine.
11. Release the battery cart floor lock.
12. Pull the battery cart away from the machine.
13. Perform the previous steps in the reverse order to install batteries into the machine.

REAR SQUEEGEE GUARD (OPTION)

The rear squeegee protector helps protect the rear squeegee from being damaged.



To engage the rear squeegee protector, pull the pin, lower the protector bar, and reinsert the pin.



OPERATION

SPRAY NOZZLE (OPTION)

The spray nozzle is used to clean the machine and surrounding areas. The solution tank provides a water/solution supply for the spray nozzle.

NOTE: DO NOT get water on electronic components when using the spray nozzle to clean the machine.

FOR SAFETY: Before leaving or servicing machine, stop on level surface and turn off machine.

1. Turn on the machine.
2. Press the top of the *Spray nozzle switch* to turn on the spray nozzle. The light on the switch will come on when the spray nozzle is turned on.



3. Pull the spray nozzle out from the back of the machine and clean as needed.



FOR SAFETY: Wear eye and ear protection when using pressurized air or water.

4. When finished cleaning, gently pull the hose and allow the spray nozzle hose to retract back into the machine.

NOTE: Continue holding onto the spray nozzle and control the hose while it is retracting back into the machine. The machine and / or the spray nozzle assembly could be damaged if the spray nozzle hose is released and allowed to rapidly retract into the machine.

5. Place the spray nozzle onto the hook.

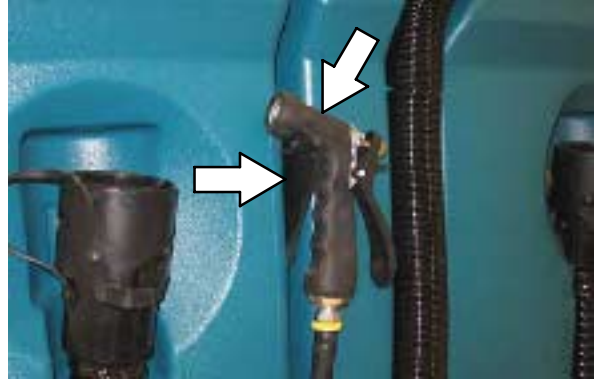

6. Press the bottom of the *Spray nozzle switch* to turn off the water supply. The light on the switch will turn off when the spray nozzle is turned off.

OPERATION

MACHINE TROUBLESHOOTING

Problem	Cause	Remedy
Trailing water - poor or no water pickup	Worn squeegee blades	Rotate or replace squeegee blades
	Squeegee out of adjustment	Adjust squeegee
	Vacuum hose clogged	Flush vacuum hose
	Vacuum fan inlet filter dirty	Clean inlet filter
	Debris caught on squeegee	Remove debris from squeegee
	Vacuum hose to squeegee or recovery tank disconnected or damaged	Reconnect or replace vacuum hose
	Tank cover not completely closed	Check for obstructions
	Torn seals on recovery tank	Replace seals
Vacuum fan will not turn on	Recovery tank full	Drain recovery tank
	Foam filling recovery tank	Empty recovery tank
		Use less or change detergent
		Use a defoamer
Little or no solution flow to the floor	Solution tank empty	Fill solution tank
	Solution flow turned off	Turn solution flow on
	Solution supply lines plugged	Flush solution supply lines
	Solution solenoid clogged or stuck	Clean or replace
Poor scrubbing performance	Debris caught on scrub brushes	Remove debris from brushes
	Improper detergent or brush used	Contact TENNANT representative for recommendations
	Worn scrub brush(es)	Replace scrub brush(es)
	Excessive brush pressure	Reduce scrub brush down pressure
	Uneven brush pressure	Level scrub head
	Broken brush drive belts on cylindrical scrub head	Replace belts
	Low battery charge	Charge batteries until the charger automatically turns off
Poor sweeping performance (Machines equipped with Pre-Sweep option only)	Brush bristles worn	Replace brush
	Debris caught in brush drive mechanism	Remove debris from the drive mechanism.
	Hopper full	Empty hopper
	Vacuum debris bag full	Replace vacuum debris bag
	Recirculation skirt damaged	Replace recirculation skirt
	Wrong sweeping brush	Contact TENNANT representative for recommendations
	Main brush drive failure	Contact TENNANT service personnel

Problem	Cause	Remedy
ES System does not operate	<i>ES button</i> is turned off	Turn on <i>ES button</i>
	ES sensor in tank dirty not in correct position	Clean / reposition sensor
	Clogged ES pump filter	Clean ES filter
	Water level in recovery tank too low	Fill recovery tank about half full
	Water level in solution tank too low	Fill solution tank
FaST System does not operate	FaST button is turned off	Turn on the FaST button
	FaST circuit breaker tripped	Determine cause and reset the 15A circuit breaker button
	Clogged FaST PAK supply hose and/or connector	Soak connector and hose in warm water and clean
	FaST PAK carton is empty or not connected	Replace FaST PAK carton and/or connect supply hose
	FaST system is not primed	To prime, operate the FaST solution system for 5 to 10 minutes
	Clogged flow control orifice/screen	Remove and clean orifice/screen
	Faulty pump	Contact Tennant representative
	Clogged filter screen	Drain solution tank and clean filter screen
	Faulty detergent timer module	Contact Tennant representative
ec-H2O Model: Warning and fault indicator light blinking red	Mineral deposit build-up in module	Flush module (See <i>ec-H2O</i> MODULE FLUSH PROCEDURE)
ec-H2O Model: Warning and fault indicator light solid red	Clogged module	Contact Service Center
	Defective solution pump	Replace solution pump

MAINTENANCE

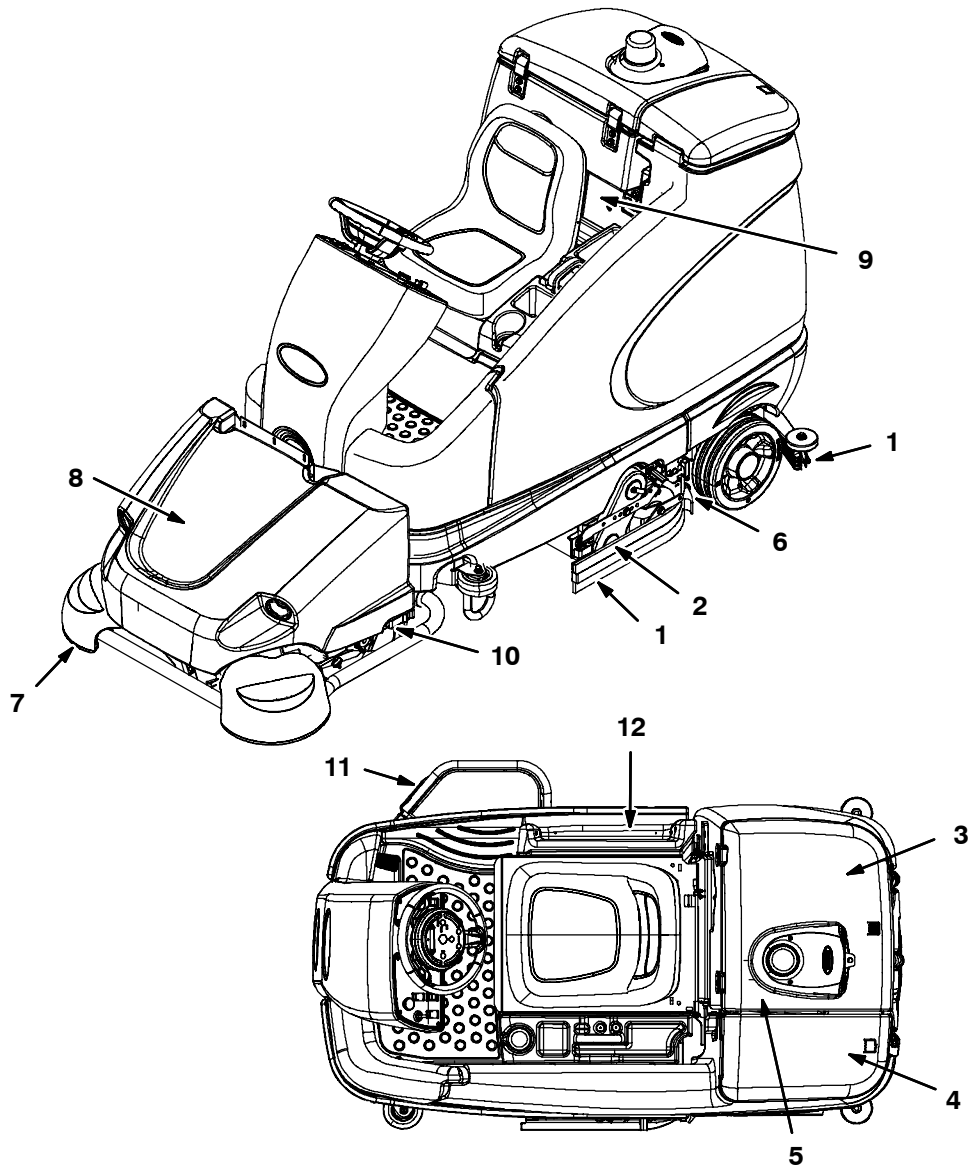

356071

MAINTENANCE CHART

Interval	Key	Description	Procedure	Lubricant/ Fluid	No. of Service Points
Daily	1	Side and rear squeegees	Check for damage and wear	-	3
	2	Main brushes	Check for damage, wear, debris	-	2
	3	Recovery tank	Clean tank	-	1
	3	Recovery tank (ES only)	Clean ES filter	-	1
	4	Solution tank (ES only)	Clean solution supply filter	-	1
	5	Vacuum fan inlet filter	Clean	-	1
	6	Cylindrical brushes only: Debris tray	Clean	-	1

Interval	Key	Description	Procedure	Lubricant/ Fluid	No. of Service Points
Daily	7	Pre-Sweep side brushes	Check for damage, wear, debris	-	2
	10	Pre-Sweep main bush	Check for damage, wear, debris	-	1
	8	Pre-Sweep debris hopper	Clean	-	1
	11	Side brush	Check for damage, wear, debris	-	1
	11	Side brush squeegee	Check for damage and wear	-	1
50 Hours	2	Main brushes (cylindrical)	Rotate brushes from front to rear	-	2
	9	FaST/Solution filter screen	Clean	-	1
	12	Battery cells	Check electrolyte level	DW	3
	1	Side and rear squeegees	Check deflection and leveling	-	6

LUBRICANT/FLUID

DW Distilled water.

NOTE: More frequent maintenance intervals may be required in extremely dusty conditions.

BATTERIES

The batteries are designed to hold their power for long periods of time between charges. The lifetime of the batteries is limited by the number of charges the batteries receive. To get the most life from the batteries, charge them when the last battery discharge indicator segment flashes (20% charge left). Use an automatic charger with the proper rating for the batteries.

Check the electrolyte level in each battery cell before and after charging, and after every 50 hours of operation. Do not charge the batteries unless the fluid is slightly above the battery plates. If needed, add just enough distilled water to cover the plates. Never add acid to the batteries. Do not overfill. Always keep the battery caps on, except when adding water or taking hydrometer readings.

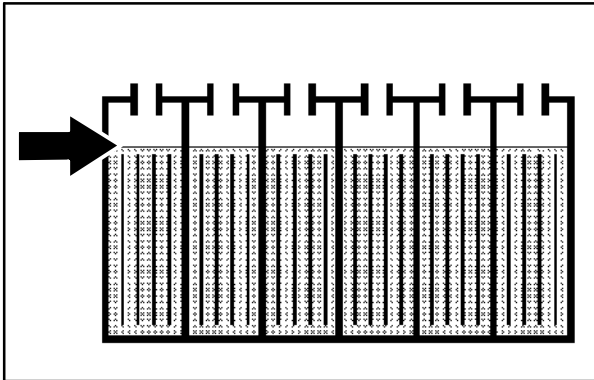

Objects made of metal can potentially short circuit the batteries. Keep all metallic objects off the batteries. Replace any worn or damaged wires.

CHARGING THE BATTERIES (OFF-BOARD CHARGER)

1. Drive the machine to a flat, dry surface in a well-ventilated area.
2. Stop the machine and turn the machine power off.

FOR SAFETY: Before leaving or servicing machine, stop on level surface and turn off machine.

3. Lift the operator seat open and engage the seat support bar.
4. Check the electrolyte level in all the battery cells.

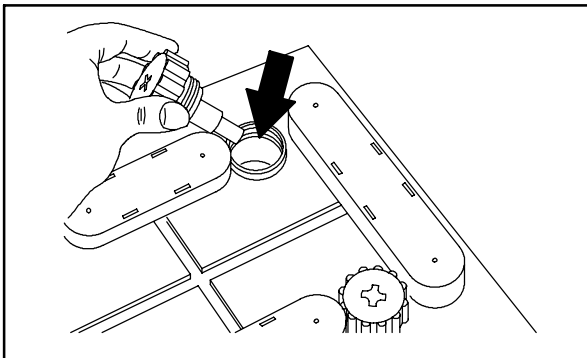

08247

5. If the level is low, add just enough distilled water to cover the battery plates. **DO NOT OVERFILL.** The batteries can overflow during charging due to expansion.

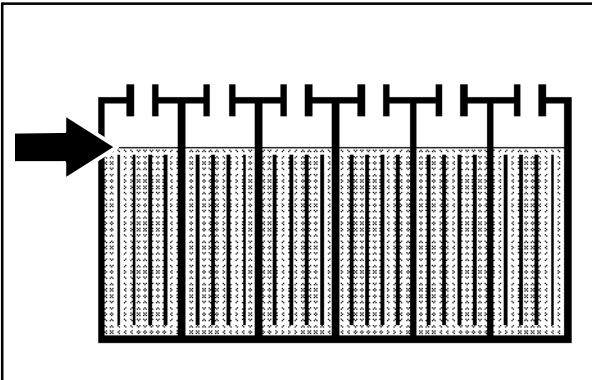

NOTE: Make sure the battery caps are in place while charging.

FOR SAFETY: When maintaining or servicing machine, avoid contact with battery acid.

6. Plug the battery charger into the remote battery charge connector.

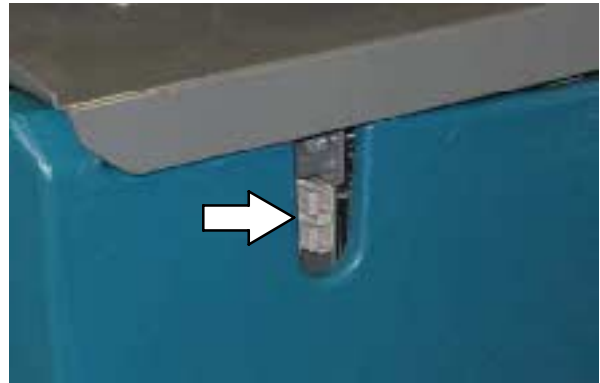

WARNING: Batteries emit hydrogen gas. Explosion or fire can result. Keep sparks and open flame away. Keep covers open when charging.

NOTE: If the red "FAULT CODE" light flashes when the batteries are plugged into the charger, refer to the charger manufacturer manual for fault code definitions.

7. The Tennant charger will start automatically. When the batteries are fully charged, the Tennant charger will automatically turn off.

NOTE: Set the charger to the proper rating for the batteries to prevent damage to the batteries or a reduction to the battery life.

8. After the charger has turned off, unplug the charger from the remote battery charge connector.
9. Check the electrolyte level in each battery cell after charging. If needed, add distilled water to raise the electrolyte level to about 12mm (0.4 in) below the bottom of the sight tubes.

FOR SAFETY: When maintaining or servicing machine, avoid contact with battery acid.

10. Close the operator seat.

MAINTENANCE

CIRCUIT BREAKERS

Circuit breakers are resettable electrical circuit protection devices designed to stop the flow of current in the event of a circuit overload. Once a circuit breaker is tripped, reset it manually by pressing the reset button after the breaker has cooled down.

Circuit breakers 1 through 10 are located in the front of the battery compartment.



Circuit breakers 11 through 19 are located on the electrical panel.

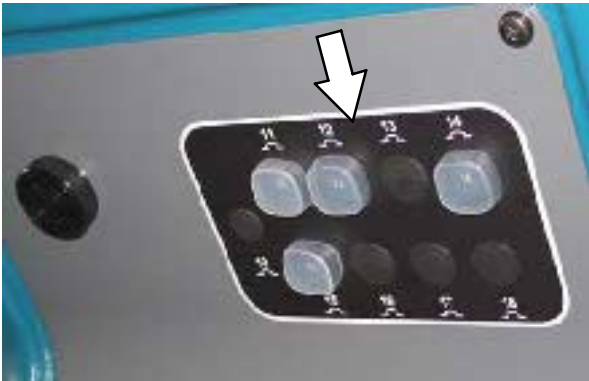

Circuit breaker 20 is located inside the optional light assembly mounted on top of the recovery tank.



If the overload that caused the circuit breaker to trip is still present, the circuit breaker will continue to stop current flow until the problem is corrected.

The chart below shows the circuit breakers and the electrical components they protect.

Circuit Breaker	Rating	Circuit Protected
CB1	2.5 A	Start
CB2	2.5 A	Key switch
CB3	2.5 A	Sweep controls (Option)
CB4	2.5 A	Main water, FaST, ES, Horn
CB5	2.5 A	Detergent meter (Option)
CB6	2.5 A	Side brush (Option)
CB7	15 A	FaST ./ ES pump (Option)
CB8	20 A	Sweep brushes (Option)
CB9	2.5 A	ec-H2O (Option)
CB10	2.5 A	ec-H2O pump (Option)
CB11	15 A	Lights (Option)
CB12	2.5 A	Headlight / Tail lights (Option)
CB13	2.5 A	Overhead guard warning light (Option)
CB14	15 A	Vacuum wand (Option)
CB15	2.5 A	Warning lights (Option)
CB16	15 A	Pre-Sweep (Option)
CB17	Open	Extra for Specials
CB18	Open	Extra for Specials
CB19	25 A	Sweep vacuum fans (Option)
CB20	25 A	Reverse alarm light (Option)

SCRUB BRUSHES

The machine can be equipped with either *disk* or *cylindrical* scrub brushes. Check scrub brushes daily for wire or string tangled around the brush or brush drive hub. Also check brushes or pads for damage and wear.

DISK BRUSHES AND PADS

Replace the brushes or pads when they no longer clean effectively.

Cleaning pads must be placed on pad drivers before they are ready to use. The cleaning pad is held in place with a center disk. Both sides of the pad can be used for scrubbing. Turn the pad over to use the other side.

Cleaning pads need to be cleaned immediately after use with soap and water. Do not wash the pads with a pressure washer. Hang pads, or lay pads flat to dry.

NOTE: Always replace brushes and pads in sets. Otherwise one brush or pad will be more aggressive than the other.

REPLACING DISK BRUSHES OR PAD DRIVERS

1. Raise the scrub head.
2. Turn off the machine.

FOR SAFETY: Before leaving or servicing machine, stop on level surface and turn off machine.

3. Open the left side squeegee support door.



4. Turn the brushes until the spring handles are visible.



5. Squeeze the spring handles and let the brushes drop to the floor.
6. Push the new brush under the scrub head, align the brush drive socket with the brush drive hub, and lift the brush up onto the brush drive hub.
7. Ensure the brush is securely mounted on the brush drive hub.
8. Close and secure the left side squeegee assembly.
9. Repeat procedure for the other brush.

MAINTENANCE

REPLACING DISK SCRUB PADS

1. Remove the pad driver from the machine.
2. Squeeze the spring clip together and remove the center disk from the pad driver.



3. Remove the scrub pad from the pad driver.



4. Flip or replace the scrub pad. Center the scrub pad on the pad driver and reinstall the center disk to secure the pad in place on the pad driver.
5. Reinstall the pad driver onto the machine.

CYLINDRICAL BRUSHES

Rotate the brushes from front-to-rear after every 50 hours of operation.

Replace the brushes when they no longer clean effectively.

NOTE: Replace worn brushes in pairs. Scrubbing with brushes of unequal bristle length will result in diminished scrubbing performance.

REPLACING CYLINDRICAL SCRUB BRUSHES

FOR SAFETY: Before leaving or servicing machine, stop on level surface and turn off machine.

1. Open the side squeeze support door.
2. Lift the idler plate retainer handle and unhook the retainer ring from the idler plate hook.



3. Remove the idler plate from the scrub head.



4. Remove the brush from the scrub head



5. Position the brush with the *double row end towards the scrub head opening*. Guide the new brush onto the drive hub.
6. If rotating the existing brushes, only rotate front to rear. Do NOT rotate end-for-end.

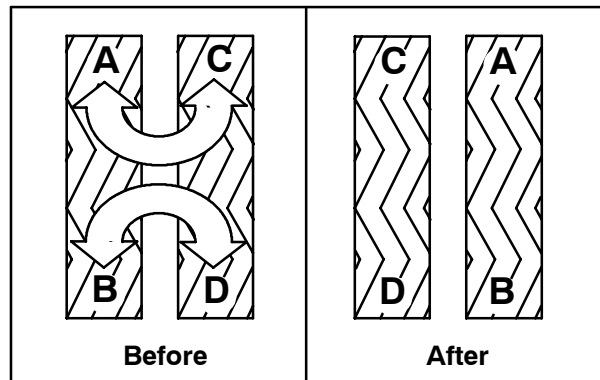

7. Reinstall the idler plate onto the scrub head and secure the idler plate into place with the idler plate retainer.
8. Repeat for the other brush on the other side of the scrub head.

NOTE: Each side of the scrub head is stamped with a letter. The idler door is stamped with the same letter. Make sure the letter on the idler door matches the letter on the scrub head when reinstalling the doors.

SIDE BRUSH (OPTION)

Check the side brush daily for wear or damage. Remove any tangled string or wire from the side brush or side brush drive hub.

REPLACING THE SIDE BRUSH

Replace the brush when it no longer cleans effectively.

1. Start the machine and press the side brush switch.
2. Shut off the machine after the side brush rotates from under the side guard, but before the side brush assembly lowers to the floor.



FOR SAFETY: Before leaving or servicing machine, stop on level surface and turn off machine.

3. Remove the knobs holding the side brush squeegee assembly to the machine and remove the squeegee assembly from the machine.



4. Squeeze the spring handles and let the side brush drop to the floor.

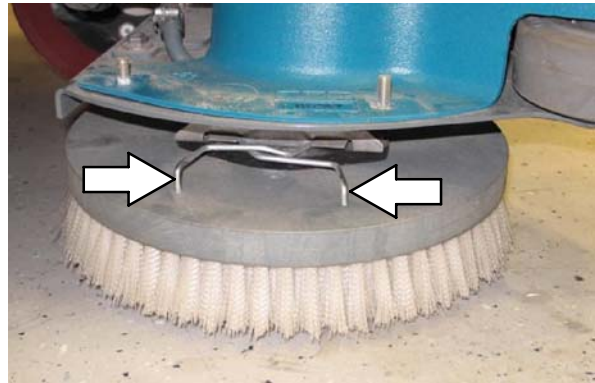

5. Remove the side brush from under the side brush assembly.
6. Place the new side brush underneath the side brush assembly and lift the side brush up onto the side brush hub until the brush locks onto the hub.
7. Reinstall the side brush squeegee assembly onto the side brush assembly.

PRE-SWEEP BRUSHES (OPTION)

The Pre-Sweep assembly is equipped with *disk* side brushes and a *cylindrical* main brush. Check the brushes daily for wire or string tangled around the brush or brush drive hub. Check the brushes daily for damage and wear.

REPLACING THE PRE-SWEEP DISK BRUSHES (OPTION)

Replace the brushes when they no longer clean effectively.

1. Turn on the machine.
2. Press the bottom of the Pre-Sweep switch to raise the Pre-Sweep assembly and stop sweeping.



3. Turn off the machine.

FOR SAFETY: Before leaving or servicing machine, stop on level surface and turn off machine.

4. Reach into the center of the brush and pull the cotter pin from the hub assembly.



5. Remove the side brush from under the Pre-Sweep assembly.
6. Install the new side brush onto the Pre-Sweep side brush assembly.

MAINTENANCE

REPLACING THE PRE-SWEEP CYLINDRICAL BRUSH (OPTION)

Replace the brush when it no longer cleans effectively.

FOR SAFETY: Before leaving or servicing machine, stop on level surface and turn off machine.

1. Turn off the machine.
2. Open the Pre-Sweep assembly cover and lock the cover open.
3. Loosen and remove the left brush arm knob.



4. Remove the left brush arm.



5. Remove the three knobs holding the Pre-Sweep side skirt and side skirt plate to the Pre-Sweep assembly.



6. Remove the side skirt plate and side skirt from the Pre-Sweep assembly.



7. Remove the cylindrical brush and replace with a new brush.



8. Guide the slotted end of the new brush onto the drive hub.
9. Reinstall the side skirt, side skirt plate, and left brush arm.

FaST SYSTEM**REPLACING THE FaST-PAK CARTON**

FOR SAFETY: Before leaving or servicing machine, stop on level surface and turn off machine.

1. Lift the operator seat open and engage the seat support bar.
2. Squeeze the button on the FaST supply hose connector, then pull the empty FaST-PAK carton out from the compartment and discard.



3. Remove the perforated knock outs from the new FaST-PAK carton. DO NOT remove the bag from the carton. Pull the hose connector from the bottom of the bag and remove the hose cap from the connector.

NOTE: The FaST-PAK Floor Cleaning Concentrate is specially designed for use with the FaST system scrubbing application. NEVER use a substitute. Other cleaning solutions may cause FaST system failure.

4. Slide the FaST-PAK carton into the FaST-PAK bracket.

5. Connect the FaST supply hose to the FaST-PAK hose connector.
6. Scrub with the FaST system for a few minutes to allow the detergent to reach maximum foaming.

CLEANING THE FaST SUPPLY HOSE CONNECTOR

Soak the connector in warm water if detergent buildup is visible. When a FaST-PAK carton is not installed, store the supply hose connector on the storing plug to prevent the hose from clogging.

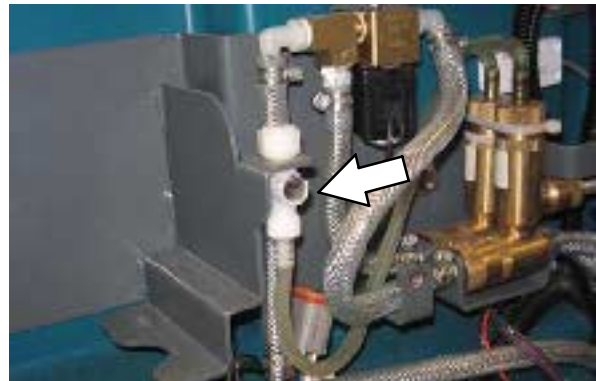

SQUEEGEE BLADES

Check the squeegee blades for damage and wear daily. When the blades become worn, rotate the blades end-for-end or top-to-bottom to a new wiping edge. Replace blades when all edges are worn.

Check the deflection of the squeegee blades daily or when scrubbing a different type of surface. Check the leveling of the rear squeegee every 50 hours of operation.

REPLACING (OR ROTATING) THE REAR SQUEEGEE BLADES

1. Lower the scrub head.

FOR SAFETY: Before leaving or servicing machine, stop on level surface and turn off machine.

2. Disconnect the vacuum hose from the rear squeegee assembly.



3. Loosen both squeegee mounting handles.

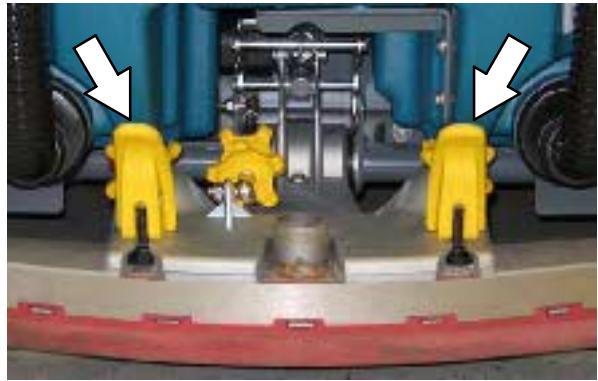

4. Pull the rear squeegee assembly from the machine.



5. Loosen the retainer latch and remove the retainer from the squeegee assembly.



6. Remove the squeegee from the squeegee assembly.



7. Slide both retainers out away from the squeegee assembly.



8. Remove the inner frame from the outer frame.

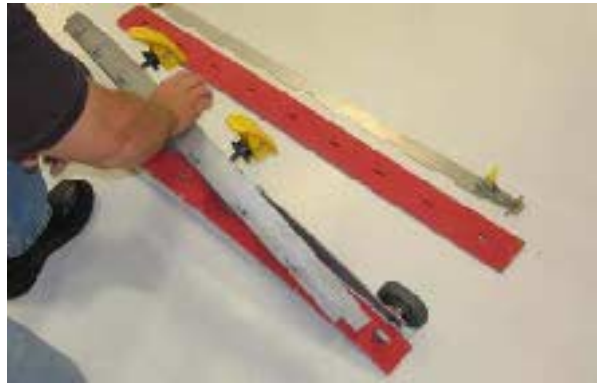

9. Remove the squeegee from the outer frame.



10. Install the rotated or new squeegee blade into the outer frame. Be sure the squeegee is completely slid down onto each tab on the outer frame.

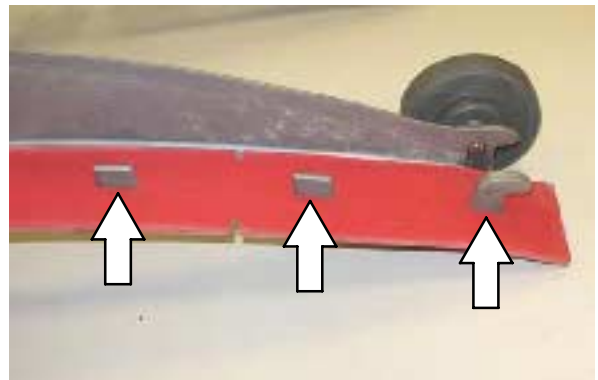

MAINTENANCE

11. Install the inner frame over the squeegee and onto the outer frame. Be sure the inner frame is tight against the top of the outer frame.

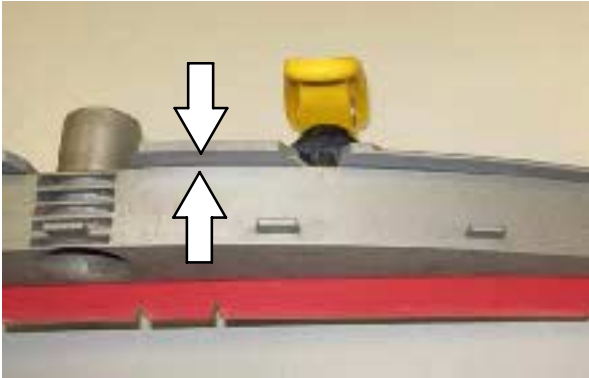

12. Slide both retainers into the squeegee assembly.



13. Place the rotated or new squeegee blade onto the inner frame. Be sure the squeegee is securely attached on each tab on the inner frame.



14. Insert the hinge end of the retainer into the hooks in the inner frame.

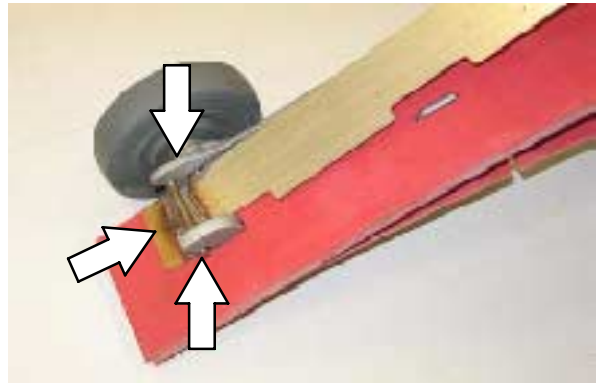

15. Install the retainer along the rest of the squeegee assembly and fasten the latch onto the other end of the squeegee assembly.

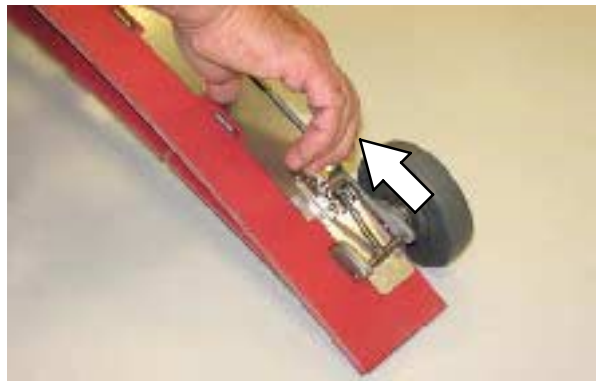
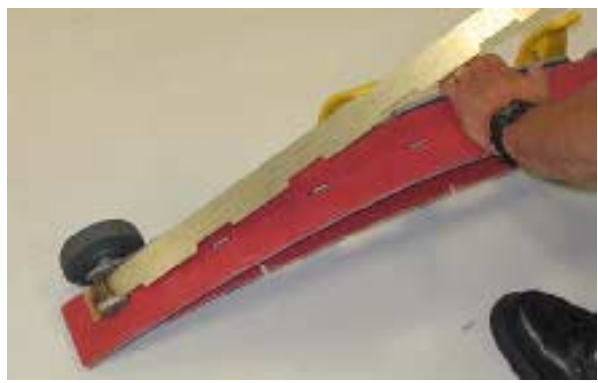

LEVELING THE REAR SQUEEGEE

Leveling the squeegee ensures the entire length of the squeegee blade is in even contact with the surface being scrubbed. Perform this adjustment on an even and level floor.

1. Lower the squeegee and drive the machine several meters (feet) forward and slowly bring the machine to a stop.

FOR SAFETY: Before leaving or servicing machine, stop on level surface and turn off machine.

2. Check the squeegee deflection over the full length of the squeegee blade.
3. If the deflection is not the same over the full length of the blade, use the tilt adjust knob to make adjustments.

DO NOT disconnect the vacuum hose from the squeegee frame when leveling squeegee.

4. To adjust the squeegee leveling, loosen the tilt lock knob.

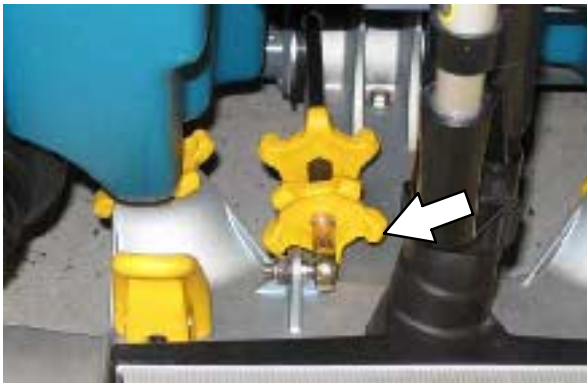

5. Turn the squeegee tilt adjust knob counter-clockwise to decrease the deflection at the ends of the squeegee blade.

Turn the squeegee tilt adjust knob clockwise to increase the deflection at the ends of the squeegee blade.

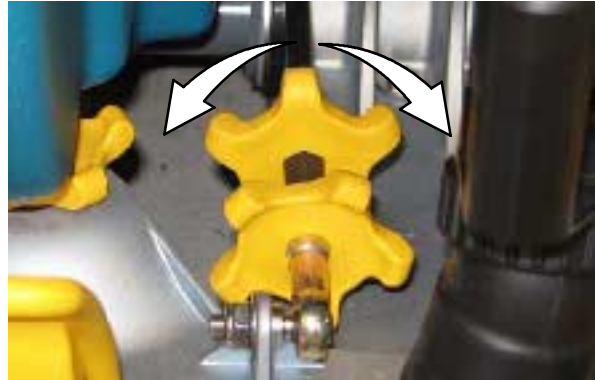

6. Tighten the tilt lock knob.
7. Drive the machine forward with the squeegee down to recheck the squeegee blade deflection if adjustments were made.
8. Readjust the squeegee blade deflection if necessary.

MAINTENANCE

ADJUSTING THE REAR SQUEEGEE BLADE DEFLECTION

Deflection is the amount of curl the overall squeegee blade has when the machine moves forward. The best deflection is when the squeegee wipes the floor dry with a minimal amount of deflection.

*NOTE: Make sure the squeegee is level before adjusting the deflection. See **LEVELING THE REAR SQUEEGEE**.*

1. Lower the squeegee and drive the machine several meters (feet) forward and slowly bring the machine to a stop.

FOR SAFETY: Before leaving or servicing machine, stop on level surface and turn off machine.

2. Look at the amount of deflection or “curl” of the squeegee blade. The correct amount of deflection is 12 mm (0.50 in) for scrubbing smooth floors and 15 mm (0.62 in) for rough floors.

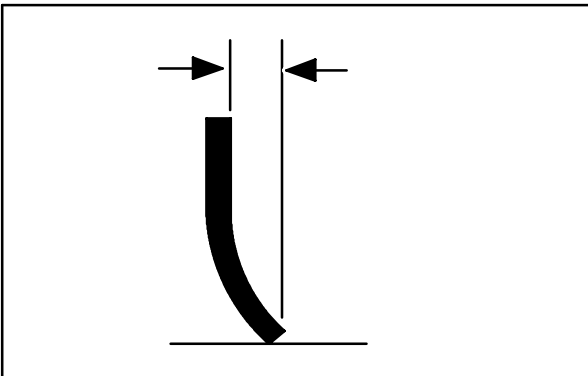

3. To adjust the overall squeegee blade deflection, loosen the lock knob.

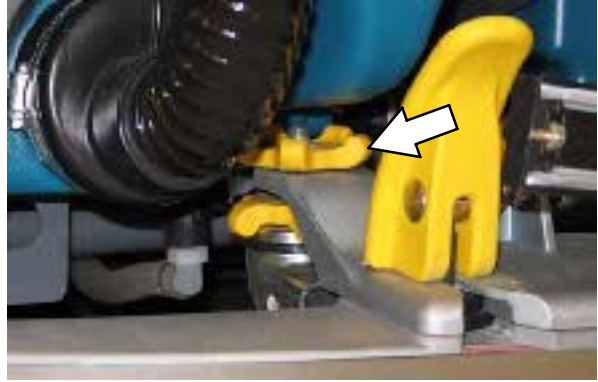

4. Turn the adjustment knobs counterclockwise to increase deflection or clockwise to decrease deflection.



5. Retighten the lock knob.
6. Drive the machine forward again to recheck the squeegee blade deflection.
7. Readjust the squeegee blade deflection if necessary.

REPLACING OR ROTATING THE SIDE SQUEEGEE BLADES

1. If necessary, raise the scrub head.

FOR SAFETY: Before leaving or servicing machine, stop on level surface and turn off machine.

2. Open the side squeegee support door.
3. Unhook the retaining band latch from the side squeegee assembly.



4. Remove the retaining band from the side squeegee assembly.



5. Remove the squeegee from the side squeegee assembly.



6. Install the rotated or new rear squeegee blade onto the side squeegee assembly.
7. Hook the retaining band onto the side squeegee assembly.

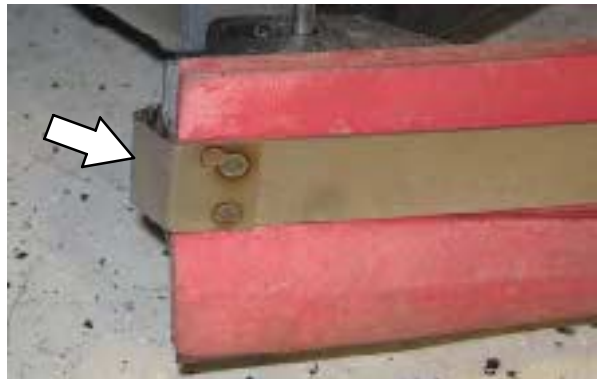

8. Fasten the retaining band latch onto the side squeegee assembly.
9. Repeat for the side squeegee on the other side of the scrub head.

MAINTENANCE

REPLACING OR ROTATING THE SIDE BRUSH SQUEEGEE BLADES (OPTION)

Check the side brush squeegee blade for damage and wear daily. Replace or rotate the blade if the leading edge is torn or worn half-way through the thickness of the blade.

1. Start the machine and press the side brush switch.
2. Shut off the machine after the side brush rotates from under the side guard, but before the side brush assembly lowers to the floor.



FOR SAFETY: Before leaving or servicing machine, stop on level surface and turn off machine.

3. Remove the knobs holding the side brush squeegee assembly to the machine and remove the squeegee assembly.



4. Loosen the retaining band latch.



5. Remove the squeegee blades and retainer from the squeegee frame.



NOTE: The squeegee blade(s) have two sets of slots for adjusting the squeegee deflection. Install / reinstall squeegees so the deflection is approximately 12 mm (0.50 in) for smooth floors and 15 mm (0.62 in) for rough floors.

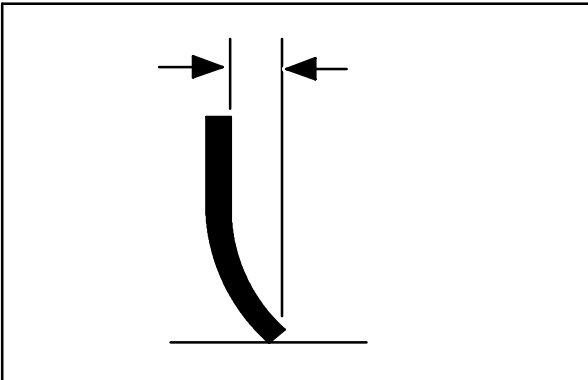

6. Install the rotated / new squeegee blades and retainer onto the side brush assembly.



7. Fasten the side brush retaining band latch.

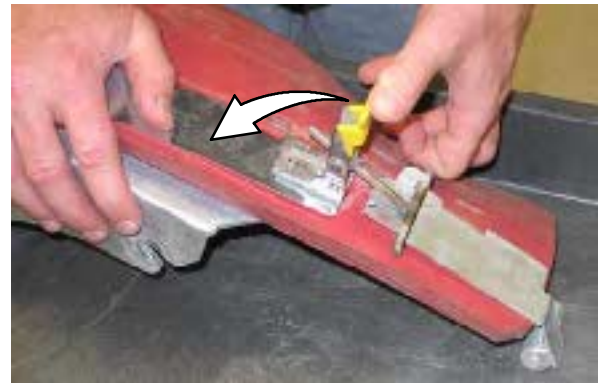

8. Reinstall the side brush squeegee assembly onto the side brush assembly.

MAINTENANCE

PUSHING, TOWING, AND TRANSPORTING THE MACHINE

PUSHING OR TOWING THE MACHINE

If the machine becomes disabled, it can be pushed or towed from the front or rear.

The parking brake must be disabled before towing or pushing the machine. To disable the brake, insert the tip of a small screw driver between the electronic brake lever and the hub. The machine can move freely when the parking brake is disabled.



Only push or tow the machine for a *very short distance* and do not exceed 3.2 kp/h (2 mph). It is NOT intended to be pushed or towed for a long distance or at a high speed.

ATTENTION! Do not push or tow machine for a long distance or damage may occur to the propelling system.

Immediately after pushing the machine, remove the screw driver from between the electronic brake lever and the hub. NEVER operate the machine with the parking brake disabled.

FOR SAFETY: Do not operate machine with brake disabled.

TRANSPORTING THE MACHINE

NOTE: Empty the recovery and solution tanks before transporting the machine.

FOR SAFETY: When unloading machine off truck or trailer, turn off machine. Use truck or trailer that will support the weight of the machine. Block machine tires. Tie machine down to truck or trailer.

Lower the scrub head and block the machine tires. Tie down the machine to the truck or trailer before transporting.

The front tie-down locations are the stabilizer legs.



The rear tie-down locations are the holes in the frame.



MACHINE JACKING

FOR SAFETY: Before leaving or servicing machine, stop on level surface and turn off machine.

Empty the recovery and solution tanks before jacking the machine.

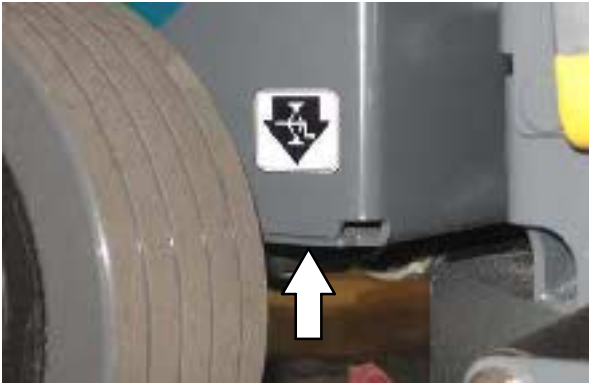

FOR SAFETY: When servicing machine, block machine tires before jacking machine up. Use a hoist or jack that will support the weight of the machine. Jack machine up at designated locations only. Support machine with jack stands.

STORAGE INFORMATION

The following steps should be taken when storing the machine for extended periods of time.

1. Drain and clean the solution and recovery tanks.
2. Park the machine in a cool (above freezing), dry area indoors. Do not expose the machine to rain.
3. Remove the batteries, or charge them every three months.

MAINTENANCE

PRIMING THE *ec-H2O* SYSTEM

Prime the *ec-H2O* system if the machine has been stored for a long period with no water in the solution tank / *ec-H2O* system.

FOR SAFETY: Before leaving or servicing machine, stop on level surface and turn off machine.

1. Fill the solution tank with clean cool water. See *FILLING THE SOLUTION TANK* section of this manual.



2. Remove the *ec-H2O* compartment cover.

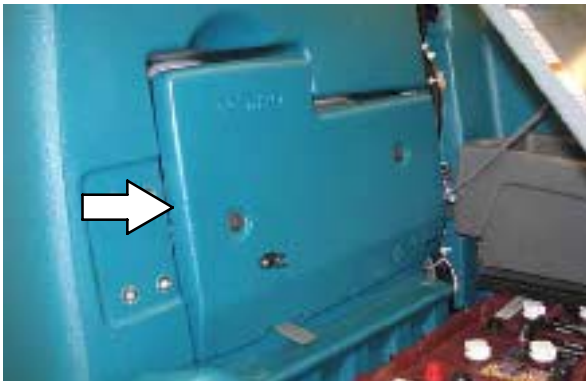

3. Remove the drain hose from the *ec-H2O* compartment.



4. Disconnect the outlet hose to the scrub head from the *ec-H2O* manifold hose.



5. Place the drain hose into an empty container.
6. Turn on the machine.
7. Press and release the *ec-H2O* module flush switch. Allow the system to drain water into the container for 2 minutes.

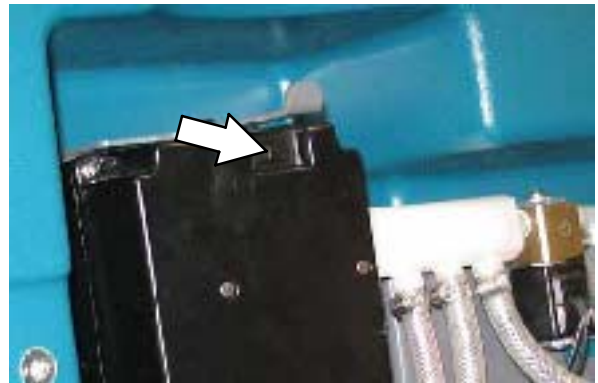

8. Press the *ec-H2O* module flush switch to shut off the system.
9. Disconnect the drain hose from the *ec-H2O* manifold hose.
10. Reconnect the outlet hose to the scrub head to *ec-H2O* manifold hose.
11. Place the drain hose back into the *ec-H2O* compartment.
12. Reinstall the *ec-H2O* compartment cover.
13. Close the operator seat cover.

SPECIFICATIONS

GENERAL MACHINE DIMENSIONS/CAPACITIES

Item	Dimension/capacity
Length	1880 mm (74 in)
Length (with Pre-Sweep)	2510 mm (99 in)
Width (less squeegee)	1040 mm (41 in)
Width (with squeegee)	1070 mm (42 in)
Width (with side brush)	1170 mm (46 in)
Height	1475 mm (58 in)
Height with overhead guard	2080 mm (82 in)
Scrubbing path width	910 mm (36 in)
Weight (Empty)	500 Kg (1100 lbs)
Weight (with standard 235 AH batteries)	860 Kg (1900 lbs)
GVWR	1270 Kg (2800 lbs)
Operating sound level at operator ear (Cylindrical scrub head)	71 dBA
Operating sound level at operator ear (Disk scrub head)	68 dBA
Vibration level at steering wheel does not exceed	1.9908 m/s ²
Vibration level at operator seat does not exceed	0.2994 m/s ²

GENERAL MACHINE PERFORMANCE

Item	Measure
Aisle turnaround width	2110 mm (83 in)
Aisle turnaround width (with Pre-Sweep)	2620 mm (103 in)
Travel Speed (Forward)	9 Km (5.6 mph)
Travel Speed (Reverse)	4 Km (2.5 mph)
Maximum rated climb and descent angle for transport	8° / 14%
Maximum rated climb and descent angle for scrubbing	4° / 7%

MACHINE DIMENSIONS

